



Visible Things™ - IoT all inclusive

THE FULLY INTEGRATED EDGE TO ENTERPRISE IoT PLATFORM
BASED ON RENASAS SYNERGY™

The Avnet Silica – Edge to Enterprise IoT Platform

Visible Things simplifies the complexity of secure edge to enterprise IoT technology. It delivers a complete evaluation and reference platform to connect smart devices right through to the cloud and enterprise software. Avnet Silica supports an ever increasing range of sensors, connectivity, gateway and security technologies, together with cloud, analytics, mobile and enterprise integration services. We regularly add new features, provide updates and deliver training on our Visible Things platform.

Visible Things is delivered in the form of many different boards which can be taken depending on the functionality required. The very nature of IoT technology requires the features delivered by these boards to be pre-integrated and tested end to end wherever possible. This fundamental principle of Visible Things allows the users to concentrate on their applications to deliver the target IoT business outcomes.

This product brief aims to describe the features delivered and provide guidance to the most appropriate board or kit to use.

Key Features

- Sensor to server security layer on top of network security
- Quick evaluation of end application
- Highest degree of flexibility
- Reduces development time significantly - time saving
- Optimised power consumption
- Integrated and tested communication path from Edge to Enterprise
- Cloud ready

Examples of Target Applications

- Remote monitoring
- Predictive maintenance of motors and drives
- Room control in homes and buildings
- Lighting and shading (indoor & outdoor)
- Security and surveillance
- Home appliances
- Smart energy (metering & in home displays)
- Health care & infrastructure
- Industrial automation, inspection, drives monitoring, sensor hub



VT-SK-002-A01 Industrial Starter Kit

SCOPE OF THE VISIBLE THINGS PLATFORM

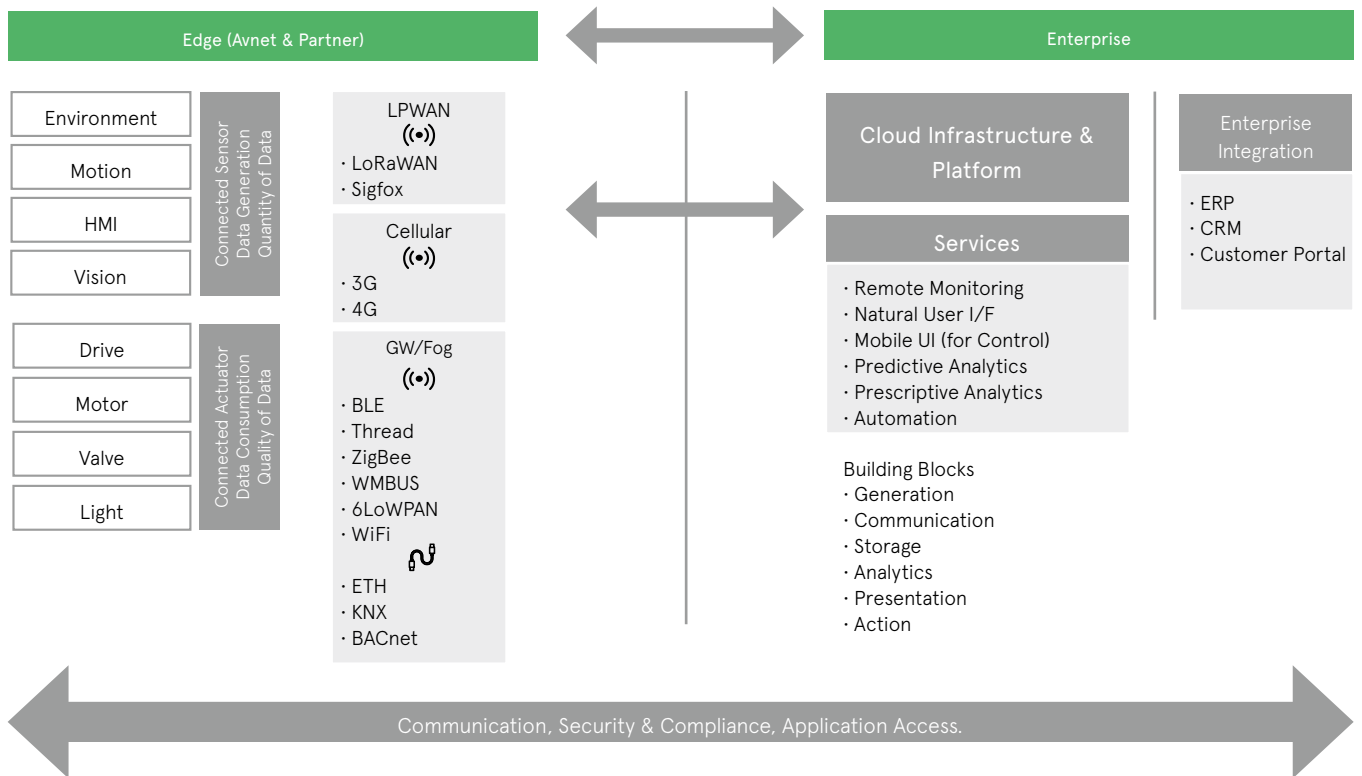

VISIBLE THINGS – FEATURES SUPPORTED

Sensors

- Connectivity
 - Bluetooth Smart
 - Sigfox
 - LoRaWAN
- Temperature
- Proximity/gesture
- Accelerometer
- Gyro
- Compass
- Humidity
- 3-Axis + temperature
- Pressure
- Ambient light
- Secure element

Gateway Functions

- Connectivity
 - Bluetooth
 - WiFi
 - 3G, 4G
 - LoRaWAN
 - Sigfox

- MCUs based on ARM Cortex™-M cores
- Camera module 1.26Mp
- 1x QVGA TFT display with touchscreen
- Audio – microphone and speaker
- NFC
- 1x PoE PD
- 2x Ethernet IEEE1588v2
- 2x USB (1x HS, 1x FS)
- 1x CAN 2.0B
- 32MB SPI flash
- 32MB SDRAM
- MicroSD card
- Secure element
- UbiquiOSTM gateway embedded software:

Ubiquios is an extremely small footprint embedded IoT stack which runs on Visible Things gateways. It manages all aspects of communication and security. It can run on bare metal (in the case of GW001), or within and RTOS (as in the case of GW002).

ubiquios™ IoT Communication Stack

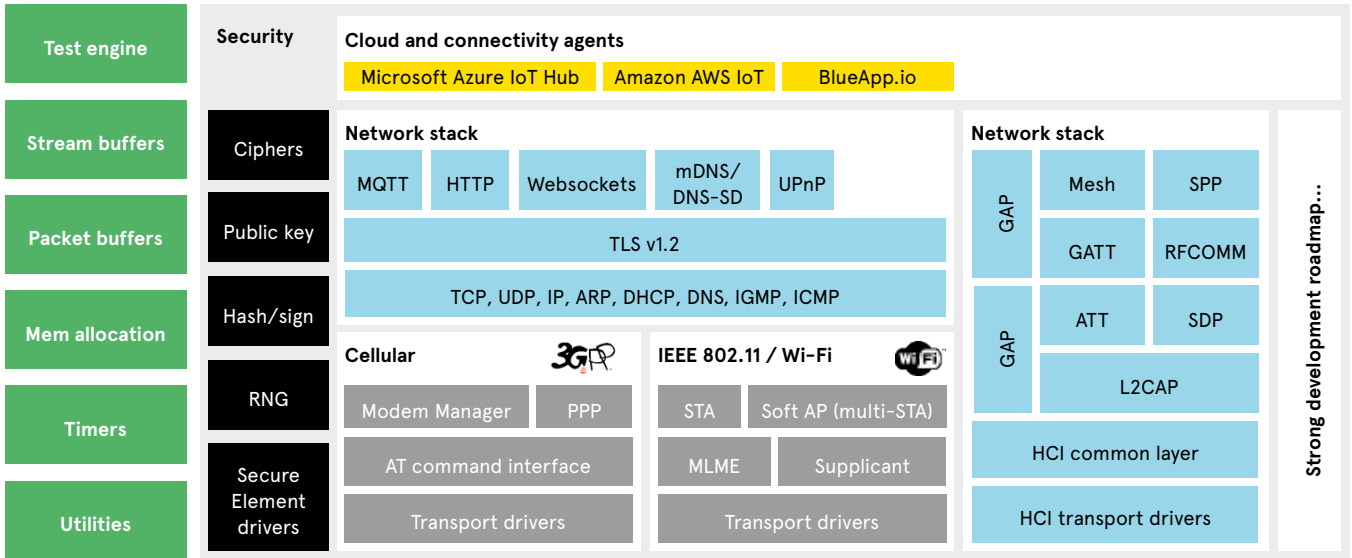

SECURITY

A new security feature is added to starter kit 2 SK002. A secure element is added to the Bluetooth sensor node and the Gateway. Server side reference code is available, and the Ubiquitous stack manages the exchange of certificates between the sensor, gateway, and server. The result is an

additional end to end application security layer. It bridges the gap between expectations of enterprise IT security and the limitations of non IP based low power wireless sensor nodes.

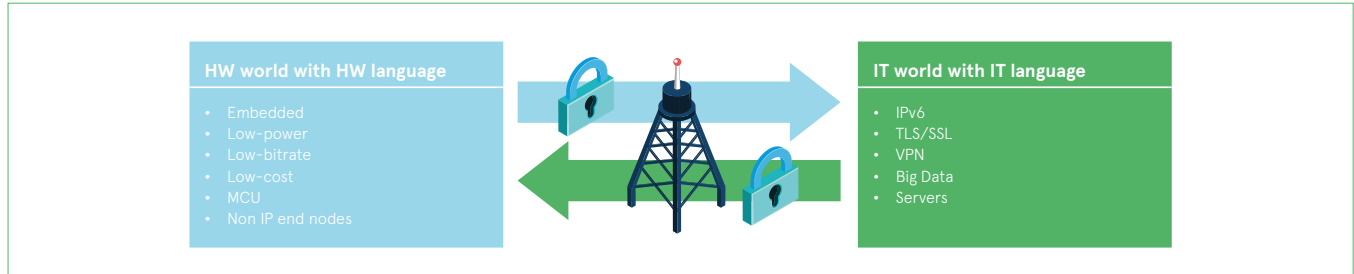

CLOUD SERVICES

Demonstrator cloud platforms are built into the Visible Things starter kits. On top of this sits a whole range of services to develop a deployed solution.

- **Evaluation** – Visible Things cloud starter kit instances.
- **Manage** – Provision, deployment, and management of the cloud service.
- **Build** – Building the Software as a Service (SaaS) specific to customer application – mobile and cloud application development, device management, security, analytics.
- **Enterprise** – Integration of new cloud based and existing systems together – API architecture, industrial use case implementation, enterprise security.

BUILD SERVICES

Avnet Silica and eco system services capabilities to create specific solutions to business issues.

- Mobile and cloud application development
- Device management and end to end security
- Cognitive and predictive analytics
- Advanced visualisation
- Managed services

ENTERPRISE INTEGRATION

Transform clients business models bringing new and existing systems together by working with our services capabilities and partner eco system.

- API architecture
- Industry demonstrators – use cases
- Enterprise class security

Enterprise Integration
IoT Industry aligned solutions



Build
Avnet Value Added Services

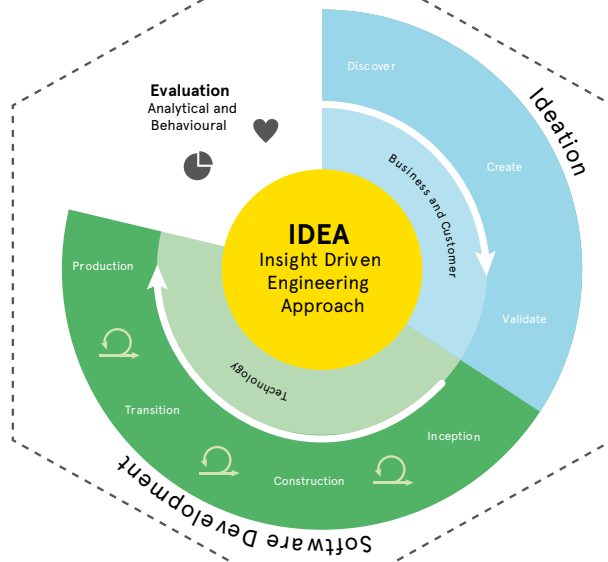

Manage
Cloud Service



Edge
Connect and Secure



Visible Things with Renesas Synergy™

THE PERFECT IoT SOLUTION PLATFORM FOR INDUSTRIAL APPLICATIONS

Avnet Silica's Visible Things Industrial starter kit provides a comprehensive edge to enterprise eco system based on the Renesas Synergy Platform, delivering a turn-key solution for many different applications where Renesas Synergy is used as the key element that can handle an outstanding range of connectivity tasks.

Design engineers face many challenges in the embedded system and growing IoT markets – acquiring and mastering new technologies, developing code for low-level system infrastructure, performing integration and test, meeting aggressive schedules – all while facing intense cost and resource pressures. A comprehensive embedded software platform is the answer to these challenges by freeing resources to develop differentiated products instead of creating and maintaining the common fundamental software functions used in many applications. Synergy is a truly complete, fully tested and qualified, systematically maintained and supported platform.

A comprehensive product that integrates software, a scalable family of microcontrollers plus a complete development environment including the TraceX® graphical events trace tool, debugger, compiler, configurators and smart manuals. You start your application development directly at the Application Program Interface (API) level.

THE RENESAS SYNERGY™ PLATFORM CONSISTS OF FIVE KEY ELEMENTS:

- Qualified commercial-grade software with a common API
- Scalable and compatible ARM Cortex-M based microcontrollers
- Intuitive professional development tools and kits
- Time-saving end-to-end solutions
- Click-through licensing plus a collection of specialized add-on software

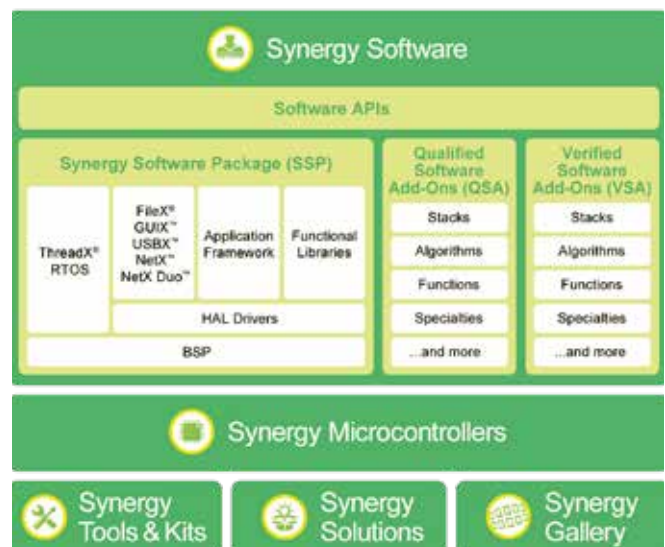

VISIBLE THINGS DELIVERABLES

The Visible Things starter kits consist of a smart sensor with Bluetooth connectivity through to a gateway. The gateway then manages connectivity through the cloud services where sensor data can be visualised and managed with simple tools. A mobile app is delivered to the boards and also directly visualise sensor data.

Both kits are designed to work together with quick start guides to quickly get up and running with a proof of concept. Technical documentation and design files are then available once development and integration of the technology into products starts.

Further smart sensors and PMODs are then available and described below to evaluate further connectivity such as GSM and LPWAN.

An Avnet mobile application for iOS and Android is provided for configuration of the devices locally and to support connections to the cloud service. The application is fully integrated with a quick start guide to make it easy to connect the system from edge to enterprise.

SK002 - INDUSTRIAL STARTER KIT

Industrial Gateway with Energy Harvesting Environmental Sensor

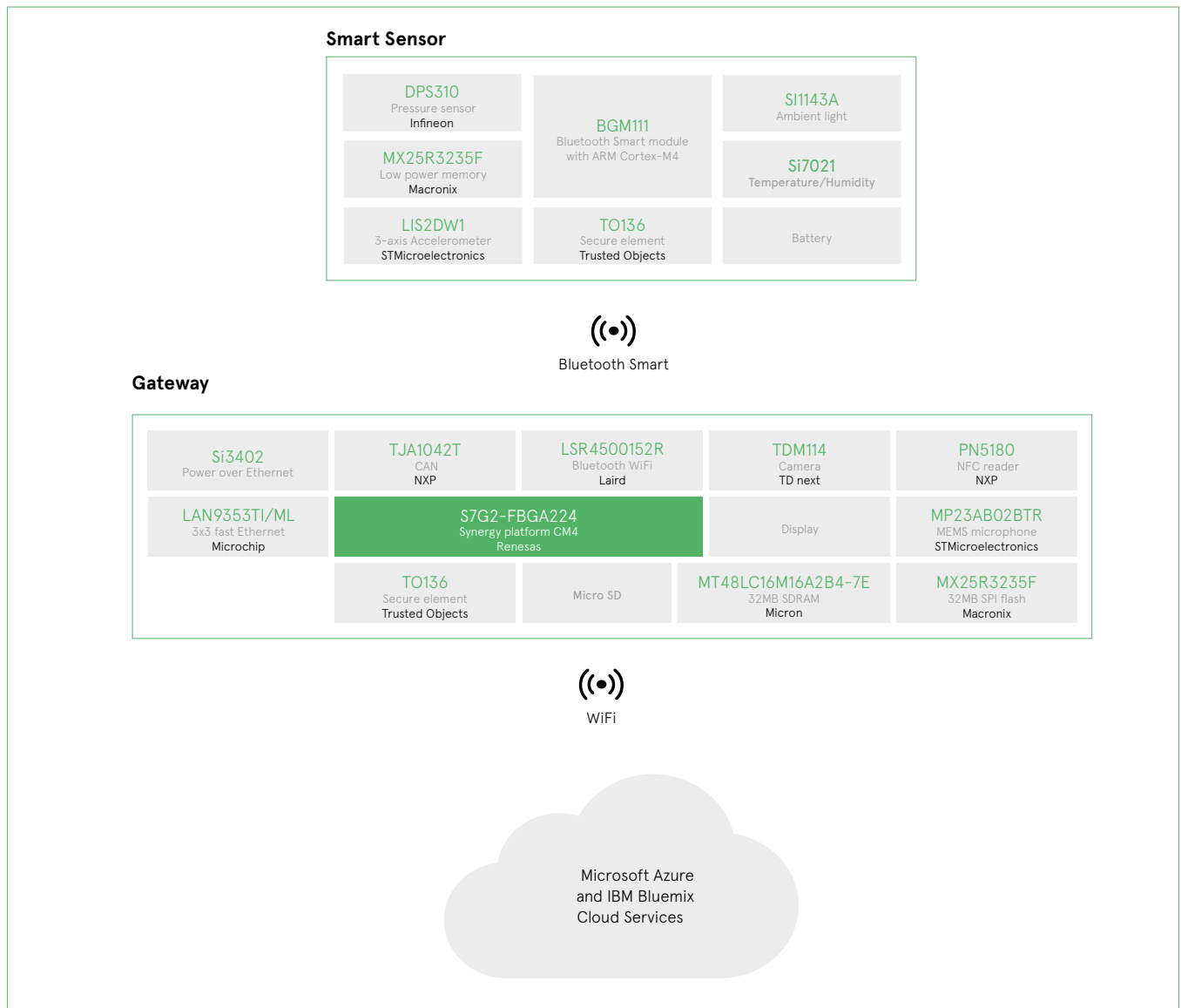

SIGFOX SMART SENSOR

The Sigfox Smart Sensor, together with local sensors, is managed by an NXP Cortex-M0 microcontroller. Messages are sent directly to a Sigfox server and then Devicepoint™ manages them into the cloud service.

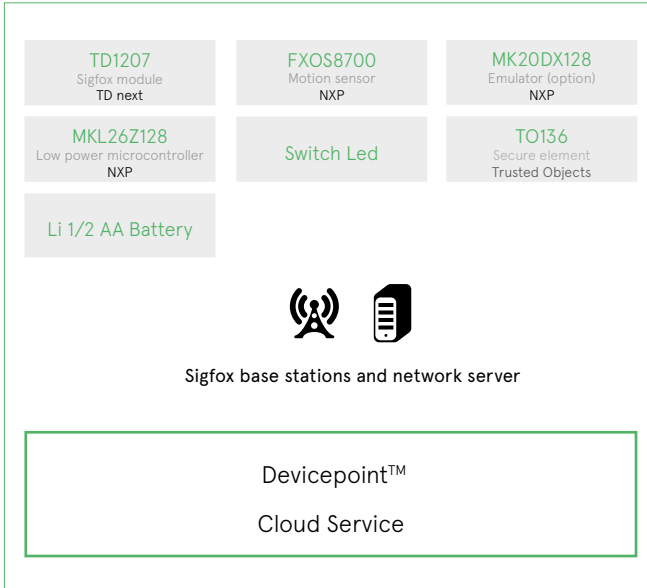

LoRaWAN PMOD

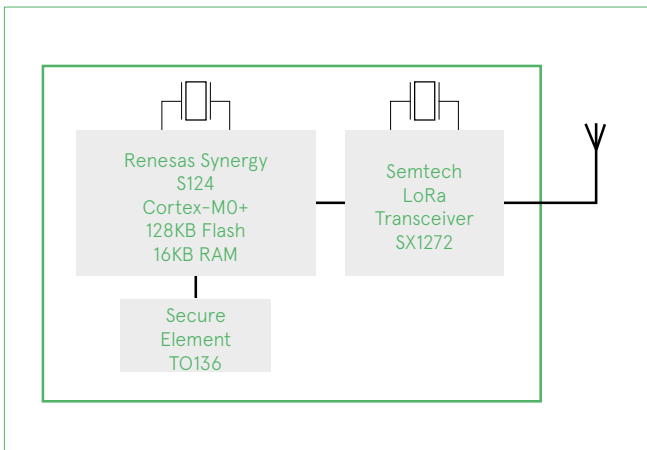

GSM PMOD

As an expansion to the gateway board a GSM PMOD is offered with embedded SIM and SIM connector options.

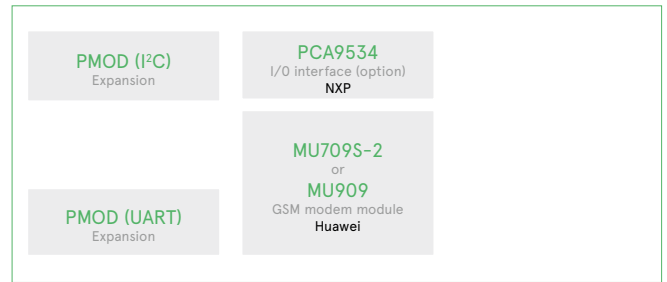

ORDER CODES

Part Number	Description	Comments
VT-SK-002-A01-LAI	Industrial starter kit	Includes: <ul style="list-style-type: none"> Industrial gateway Sensor board Power adapter
VT-SS-003-A	Sigfox Smart sensor	
PMOD-COM-003-A01	LoRaWAN PMOD	
PMOD-COM-019E-B01	3G PMOD	With eUICC and Vodaphone profile embedded

Offices

AUSTRIA

Vienna
Phone: +43 186 642 300
Fax: +43 186 642 350
wien@avnet.eu

BELGIUM

Merelbeke
Phone: +32 9 210 24 70
Fax: +32 9 210 24 87
gent@avnet.eu

CZECH REPUBLIC (SLOVAKIA)

Prague
Phone: +420 234 091 031
Fax: +420 234 091 030
praha@avnet.eu

DENMARK

Herlev
Phone: +45 432 280 10
Fax: +45 432 280 11
herlev@avnet.eu

ESTONIA

(LATVIA, LITHUANIA)
Pärnu
Phone: +372 56 637737
paernu@avnet.eu

FINLAND

Espoo
Phone: +358 207 499 200
Fax: +358 207 499 280
helsinki@avnet.eu

FRANCE (TUNISIA)

Cesson Sévigné
Phone: +33 299 838 485
Fax: +33 299 838 083
rennes@avnet.eu

Illkirch
Phone: +33 390 402 020
Fax: +33 164 479 099
strasbourg@avnet.eu

Massy Cedex
Phone: +33 164 472 929
Fax: +33 164 470 084
paris@avnet.eu

Toulouse
Phone: +33 05 62 47 47
toulouse@avnet.eu

Vénissieux Cedex
Phone: +33 478 771 360
Fax: +33 478 771 399
lyon@avnet.eu

GERMANY

Berlin
Phone: +49 30 214 882 0
Fax: +49 30 214 882 33
berlin@avnet.eu

Freiburg
Phone: +49 761 881 941 0
Fax: +49 761 881 944 0
freiburg@avnet.eu

Hamburg
Phone: +49 40 608 235 922
Fax: +49 40 608 235 920
hamburg@avnet.eu

Holzwickede
Phone: +49 2301 919 0
Fax: +49 2301 919 222
holzwickede@avnet.eu

Lehrte
Phone: +49 5132 5099 0
hannover@avnet.eu

Leinfelden-Echterdingen
Phone: +49 711 782 600 1
Fax: +49 711 782 602 00
stuttgart@avnet.eu

Leipzig
Phone: +49 34204 7056 00
Fax: +49 34204 7056 11
leipzig@avnet.eu

Nürnberg
Phone: +49 911 24425 80
Fax: +49 911 24425 85
nuernberg@avnet.eu

Pöing
Phone: +49 8121 777 02
Fax: +49 8121 777 531
muenchen@avnet.eu

Wiesbaden
Phone: +49 612 258 710
Fax: +49 612 258 713 33
wiesbaden@avnet.eu

HUNGARY

Budapest
Phone: +36 1 43 67215
Fax: +36 1 43 67213
budapest@avnet.eu

ITALY

Cusano Milanino
Phone: +39 02 660 921
Fax: +39 02 660 923 33
milano@avnet.eu

Firenze
Phone: +39 055 436 039 2
Fax: +39 055 431 035
firenze@avnet.eu

Modena
Phone: +39 059 348 933
Fax: +39 059 344 993
modena@avnet.eu

Padova
Phone: +39 049 807 368 9
Fax: +39 049 773 464
padova@avnet.eu

Rivoli
Phone: +39 011 204 437
Fax: +39 011 242 869 9
torino@avnet.eu

Roma Tecnocittà
Phone: +39 06 412 319 10
Fax: +39 06 413 116 1
roma@avnet.eu

NETHERLANDS

Breda
Phone: +31 765 722 700
Fax: +31 765 722 707
breda@avnet.eu

NORWAY

Asker
Phone: +47 667 736 00
Fax: +47 667 736 77
asker@avnet.eu

POLAND

Gdansk
Phone: +48 58 307 81 51
Fax: +48 58 307 81 50
gdansk@avnet.eu

Katowice
Phone: +48 32 259 50 10
Fax: +48 32 259 50 11
katowice@avnet.eu

Warszawa
Phone: +48 222 565 760
Fax: +48 222 565 766
warszawa@avnet.eu

PORTUGAL

Vila Nova de Gaia
Phone: +35 1 223 779 502
Fax: +35 1 223 779 503
porto@avnet.eu

ROMANIA (BULGARIA)

Bucharest
Phone: +40 21 528 16 32
Fax: +40 21 529 68 30
bucuresti@avnet.eu

RUSSIA (BELARUS, UKRAINE)

Moscow
Phone: +7 495 737 36 70
Fax: +7 495 737 36 71
moscow@avnet.eu

Saint Petersburg
Phone: +7 812 635 81 11
Fax: +7 812 635 81 12
stpetersburg@avnet.eu

SLOVENIA (BOSNIA AND HERZEGOVINA, CROATIA, MACEDONIA, MONTENEGRO, SERBIA)

Ljubljana
Phone: +386 156 097 50
Fax: +386 156 098 78
ljubljana@avnet.eu

SPAIN

Barcelona
Phone: +34 933 278 530
Fax: +34 934 250 544
barcelona@avnet.eu

Galdàcano. Vizcaya
Phone: +34 944 572 777
Fax: +34 944 568 855
bilbao@avnet.eu

Las Matas
Phone: +34 913 727 100
Fax: +34 916 369 788
madrid@avnet.eu

SWEDEN

Sundbyberg
Phone: +46 8 587 461 00
Fax: +46 8 587 461 01
stockholm@avnet.eu

SWITZERLAND

Rothrist
Phone: +41 62 919 555 5
Fax: +41 62 919 550 0
rothrist@avnet.eu

TURKEY (GREECE, EGYPT)

Kadikoy Istanbul
Phone: +90 216 528 834 0
Fax: +90 216 528 834 4
istanbul@avnet.eu

UNITED KINGDOM (IRELAND)

Berkshire
Phone: +44 1628 512 900
Fax: +44 1628 512 999
maidenhead@avnet.eu

Bolton
Phone: +44 1204 547 170
Fax: +44 1204 547 171
bolton@avnet.eu

Bucks. Aylesbury
Phone: +44 1296 678 920
Fax: +44 1296 678 939
aylesbury@avnet.eu

Stevenage, Herts, Meadway
Phone: +44 1438 788 310
Fax: +44 1438 788 250
stevenage@avnet.eu

ISRAEL

Tel-Mond
Phone: +972 (0)9 7780280
Fax: +972 (0)3 760 1115
avnet.israel@avnet.com

SOUTH AFRICA

Cape Town
Phone: +27 (0)21 689 4141
Fax: +27 (0)21 686 4709
sales@avnet.co.za

Durban
Phone: +27 (0)31 266 8104
Fax: +27 (0)31 266 1891
sales@avnet.co.za

Johannesburg
Phone: +27 (0)11 319 8600
Fax: +27 (0)11 319 8650
sales@avnet.co.za



Mixed Sources
Product group from well-managed
forests and other controlled sources
www.fsc.org Cert no. IC-COC-100065
© 1996 Forest Stewardship Council