

Power Relays (Over 2A)



HE-N RELAYS

High capacity 120A 480V AC 1 Form A power relay

〈Protective construction〉 Flux-resistant type

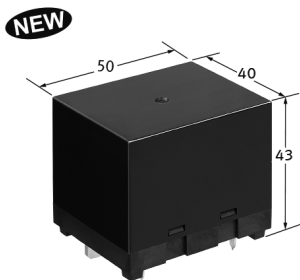

(Unit : mm)

FEATURES

1. High capacity : Max. switching current 120A
2. Compact Size : W (50mm) x L (40mm) x H (43mm)
3. Contact GAP : Min.3.6 mm (Initial)
4. Insulation distance (Initial) : Min.10.5mm (Clearance & Creepage)
5. Contributes to energy saving in devices by reducing coil holding voltage*. Coil holding power : 400mW

*Coil holding voltage : the coil voltage after applying 100ms of the reted coil voltage

APPLICATIONS

1. Inverter
2. Battery storage system
3. Stationary charging stand
4. Industrial equipment

ORDERING INFORMATION (TYPE NO.)

HE 1a N - W - DC - Y7

- Operate voltage
N : Max.75% V of rated coil voltage
- Contact arrangement
1a : 1 Form A
- Terminal shape
W : PC board terminal(wide blade)
- Rated coil voltage (DC)
6, 9, 12, 24V
- Contact material, Contact rating
Y7 : AgNi type, 120A

TYPES

Contact arrangement	Rated coil voltage	Type No.	Standard packing	
			Carton	Outer carton
1 Form A	6 V DC	HE1aN-W-DC6V-Y7	10 pieces	50 pieces
	9 V DC	HE1aN-W-DC9V-Y7		
	12 V DC	HE1aN-W-DC12V-Y7		
	24 V DC	HE1aN-W-DC24V-Y7		

RATING

Coil data

- Operating characteristics such as ‘Operate voltage’ and ‘Release voltage’ are influenced by mounting conditions, ambient temperature, etc.
Therefore, please use the relay within ± 5% of rated coil voltage.
- ‘Initial’ means the condition of products at the time of delivery.

Rated coil voltage	Operate voltage* (at 20°C)	Release voltage* (at 20°C)	Rated operating current (±10%, at 20°C)	Coil resistance (±10%, at 20°C)	Rated operating power	Max. allowable voltage (at 55°C)
6 V DC	Max. 75% V of Rated coil voltage (Initial)	Min. 5% V of Rated coil voltage (Initial)	417 mA	14.4 Ω	2,500 mW	110% V of Rated coil voltage
9 V DC			278 mA	32.4 Ω		
12 V DC			208 mA	57.6 Ω		
24 V DC			104 mA	230 Ω		

*square, pulse drive

Specifications

Item		Specifications
Contact data	Contact arrangement	1 Form A
	Contact resistance (initial)	Max. 10 mΩ (by voltage drop 5 V DC 20 A)
	Contact material	AgNi type
	Contact rating (resistive)	120 A 480 V AC
	Max. switching power (resistive)	57,600 VA
	Max. switching voltage	800 V AC
	Max. switching current	120 A (AC)
	Min. switching load (reference value) ¹	100 mA 5 V DC
Insulation resistance (initial)		Min. 1,000 MΩ (At 500 V DC, Measured portion is the same as the case of dielectric strength.)
Dielectric strength (initial)	Between open contacts	2,000 Vrms for 1 min. (detection current: 10 mA)
	Between contact and coil	5,000 Vrms for 1 min. (detection current: 10 mA)
Surge breakdown voltage (initial) ²		Between contact and coil 10,000 V
Coil holding voltage ³		40 to 100% V (contact carrying current: 120 A, at 20°C) 50 to 60% V (contact carrying current: 120 A, at 85°C)
Time characteristics (initial)	Operate time	Max. 30 ms (at rated coil voltage at 20°C, without bounce)
	Release time	Max. 10 ms (at rated coil voltage at 20°C, without bounce, without diode)
Shock resistance	Functional	98 m/s ² (half-sine shock pulse: 11 ms, detection time: 10 μs)
	Destructive	980 m/s ² (half-sine shock pulse: 6 ms)
Vibration resistance	Functional	10 to 55 Hz (at double amplitude of 1.0 mm, detection time: 10 μs)
	Destructive	10 to 55 Hz (at double amplitude of 1.5 mm)
Expected switching life		Mechanical Min. 1 × 10 ⁶ ope. (at 180 times/min.)
Conditions		Condition for use, transportation and storage ⁴ Ambient temperature: -40 to +55°C (When coil holding voltage is 40 to 100% V of rated voltage.) -40 to +85°C (When coil holding voltage is 50 to 60% V of rated voltage or storage.) Humidity: 5 to 85% R.H. (Avoid icing when using at temperatures lower than 0°C.)
Unit weight		Approx. 115 g

*1. This value can change due to the switching frequency, environmental conditions, and desired reliability level, therefore it is recommended to check this with the actual load.

*2. Wave is standard shock voltage of ±1.2×50μs according to JEC-212-1981.

*3. Coil holding voltage is the coil voltage after 100 ms following application of the rated coil voltage.

*4. The upper operation ambient temperature limit is the maximum temperature that can satisfy the coil temperature rise value. Refer to "1. Usage, transport and storage conditions" in NOTES.

Expected electrical life

Conditions : Resistive load

Type	Switching capacity	Number of operations
1 Form A	120 A 480 V AC	Min. 1,000 ope. (at 85°C, ON:OFF = 1 s:9 s)
	55 A 800 V AC	Min. 10,000 ope. (at 85°C, ON:OFF = 1 s:9 s)

REFERENCE DATA

1-1.Max. switching capacity (AC resistive load)

1-2.Max. switching capacity (DC resistive load)

2.Coil temperature characteristics (Average)

Tested sample : HE1aN-W-DC12-Y7, 6pcs.
 Measured portion : Coil inside
 Contact carrying current : 120A Ambient temperature : 20°C, 55°C, 85°C

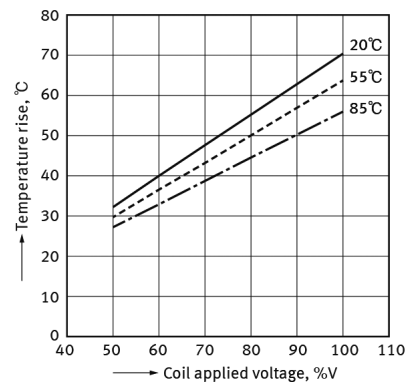
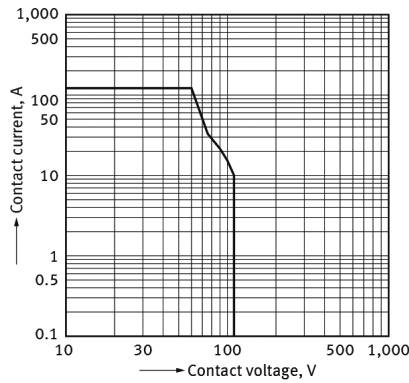
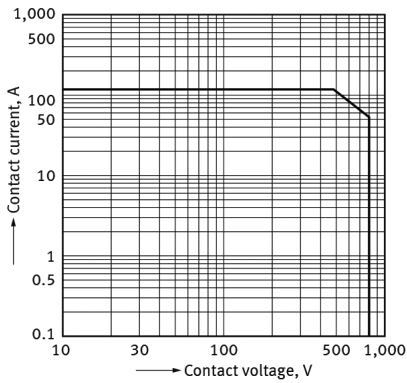

3.Ambient temperature characteristics

Tested sample : HE-N, 6 pcs.

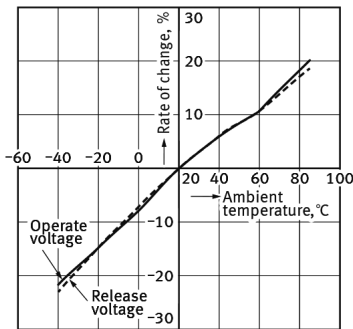

4.Electrical life test (Resistive load 480V AC 120A, at 85°C)

Tested sample : HE1aN-W-DC12-Y7, 6 pcs.
 Operation frequency : 6 times/min.
 (ON : OFF=1s : 9s)

Circuit :

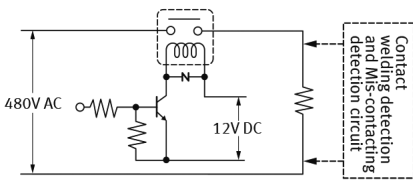

Change of Operate and release voltage

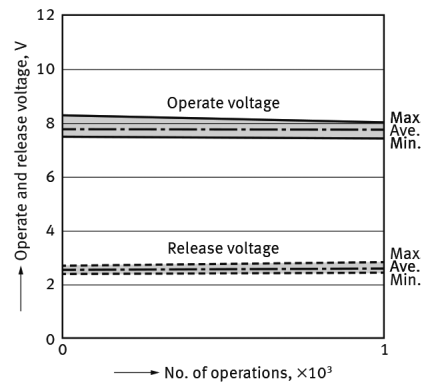

Change of contact resistance

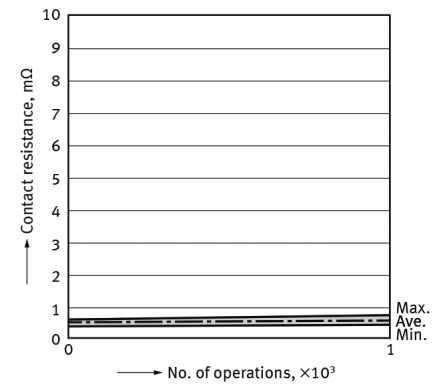

Power Relays (Over 2A) HE-N RELAYS

DIMENSIONS

CAD The CAD data of the products with a "CAD" mark can be downloaded from our Website.

Unit: mm

CAD



External Dimensions

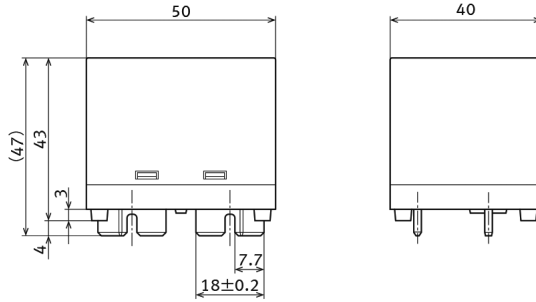

Recommended PC board pattern (BOTTOM VIEW)

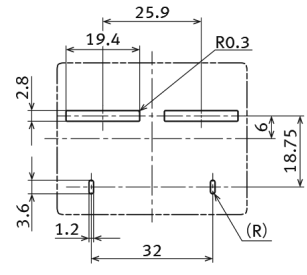

Schematic (BOTTOM VIEW)

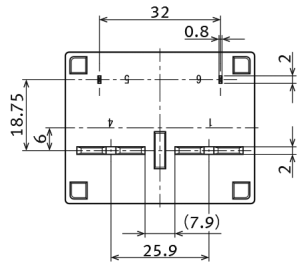
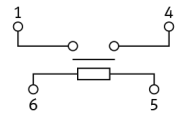

TOLERANCE;
less than 10mm: ±0.3
min.10mm~ : ±0.5

Note: Terminal dimension is a value without pre-soldering thickness.

SAFETY STANDARDS

UL/C-UL (Recognized)

File No.	Contact rating (Recognized)	Cycles	Ambient temperature
E43028	Making and Breaking 55 A, Carrying 120 A 600 V AC	6×10 ³	85°C

CSA (Certified)

CSA standard certified by C-UL

VDE (Certified)

File No.	Contact rating (Certified)	Cycles	Ambient temperature
40006681	120 A 800 V AC (cosφ=1.0)	10 ³	85°C

INSULATION CHARACTERISTICS (IEC61810-1)

Item	Characteristics
Clearance/Creepage distance (IEC61810-1)	Min. 5.5mm/8mm
Category of protection (IEC61810-1)	RT II
Tracking resistance (IEC60112)	PTI 175
Insulation material group	III a
Over voltage category	III
Rated voltage	800V
Pollution degree	2
Type of insulation (Between contact and coil)	Basic insulation
Type of insulation (Between open contact)	micro disconnection

Note: Actual value

NOTES

For cautions for use, please read "GENERAL APPLICATION GUIDELINES".

HE-N Relays Cautions for use

Condition for use, storage and transportation

1. Ambient temperature :
 - 40~+55°C
(When coil holding voltage is 40 to 100%V of rated voltage.)
 - 40~+85°C
(When coil holding voltage is 50 to 60%V of rated voltage or storage.)
2. Humidity : 5~85%RH
(Avoid icing when using at temperatures lower than 0°C.)

Note: In addition the humidity range depends on temperature. The allowable ranges are as shown in the figure.

Temperature and humidity range for usage, storage and transport
[Coil holding voltage 40~100%V]

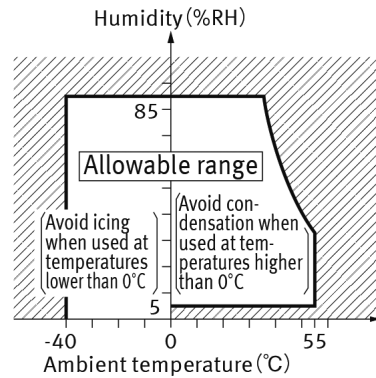

[Coil holding voltage 50~60%V]

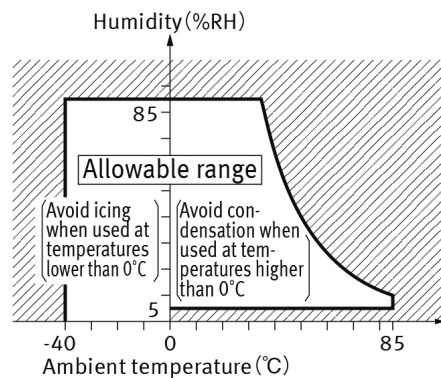

Coil surge absorber

Please use a Varistor (ZNR) or Zener diode (ZD) which the clamp voltage is at least 3 times larger than the rated voltage for the purpose of the coil surge absorber.

If the clamp voltage is less than 3 times larger than the rated voltage, electrical life of the relay specified in the specifications shall not be secured because the contact release speed becomes slower.

[Example 1: When Varistor (ZNR) is use]

Recommended Varistor	Energy capability: Min. 1 J (However, please set up the value with consideration of the worst value in use condition.)
Varistor Voltage	Min. 300% of rated voltage (Recommended Varistor voltage is at 36 V or more when the coil rated voltage is at 12 V.)

[Example 2: When Zener diode (circuit) is use]
(Set the clamp voltage at 36 V or more when the coil 1 rated voltage is at 12 V.)

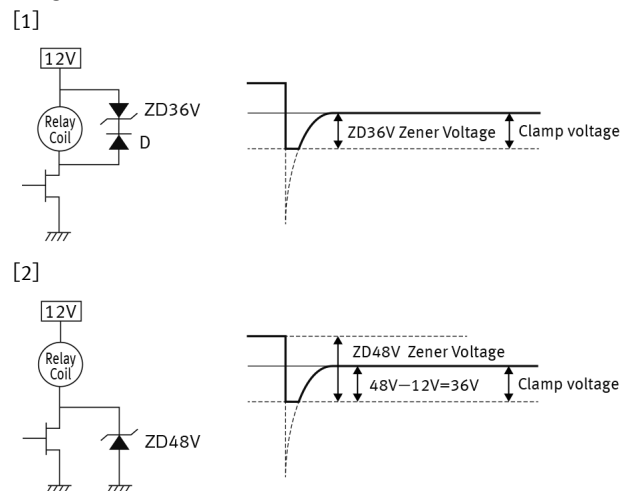

Please refer to "the latest product specifications" when designing your product.

- Requests to customers :
<https://industrial.panasonic.com/ac/e/salespolicies/>

Please contact

Panasonic Corporation

Electromechanical Control Business Division

■ 1006, Oaza Kadoma, Kadoma-shi, Osaka 571-8506, Japan
industrial.panasonic.com/ac/e/

Panasonic[®]

© Panasonic Corporation 2018